

# **JBC**

[www.jbctools.com](http://www.jbctools.com)

## **INSTRUCTION MANUAL**



### **ALS / ALES**

Stand for AL250 / ALE250-A  
Automatic-Feed Soldering Iron

This manual corresponds to the following references:

**AL-SG**

*works with control unit AL y tool AL250-A*

**ALE-SA**

*works with control unit ALU y tool ALE250-A*

**Packing List**

Included in AL-SG box:



**Stand for AL250-A Automatic-Feed Soldering Iron** ..... 1 unit

Included in ALE-SA box:



**Stand for ALE250-A Automatic-Feed Soldering Iron** ..... 1 unit

Included in both, AL-SG and ALE-SA box:



**Sponge for Stand 48 x 26.5 mm** .... 1 unit  
Ref. S7034



**Brass Wool** ..... 1 unit  
Ref. CL6210

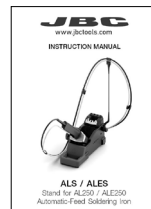

**Manual** ..... 1 unit  
Ref. 0027178

## Features and Connections

The stand includes a sleep mode that automatically reduces the tip temperature when the tool is in the stand.

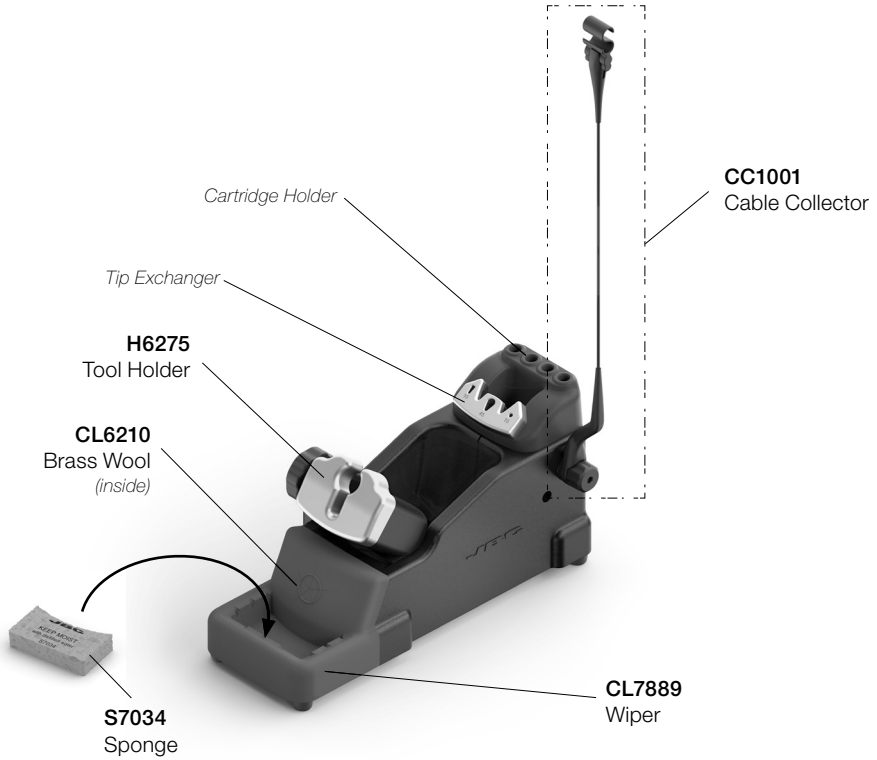

## Cable Collector and Adjustable Tool Holder

### Assembly

#### Adjustable Cable Collector (CC1001)

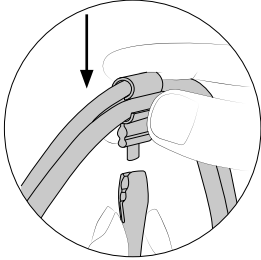

Insert the cable into the clip and then insert into it the cable collector. Do not leave the cable longer than necessary to reach the work area freely.

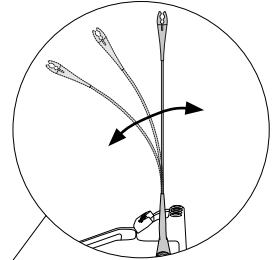

The cable collector is flexible. It accompanies and adapts to the movements during the soldering process.

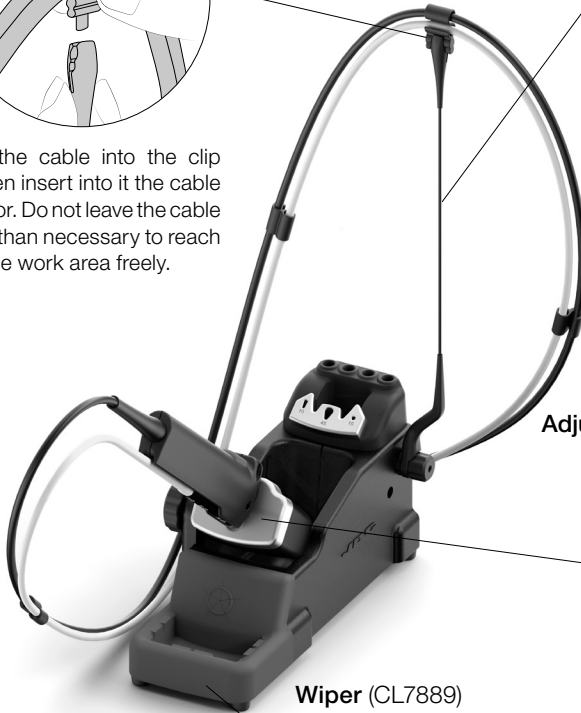

#### Adjustable Tool Holder (H6275)

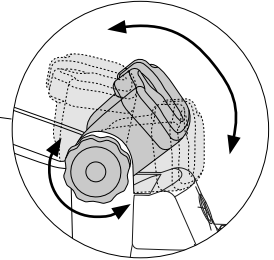

Adjust the tool holder angle to suit the work position.

#### Wiper (CL7889)

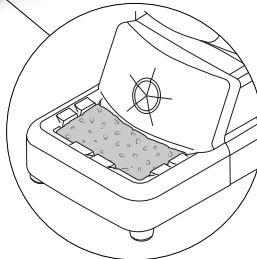

The wiper offers different ways to clean the cartridge tips. If desired use the included sponge.

## Changing Cartridges

⚠ For a safe cartridge change, unplug the tool or turn the station off before following these guidelines.

### 1. Unlocking

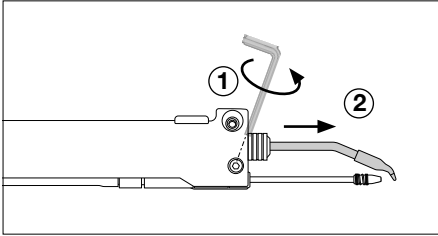

Loosen the cartridge screw (1) to release the cartridge (2).

### 2. Removing

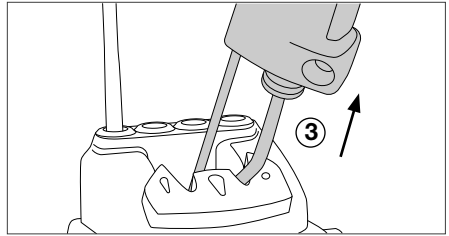

Place the cartridge in the quick tip changer extractor and pull the tool to remove the cartridge (3).

### 3. Inserting

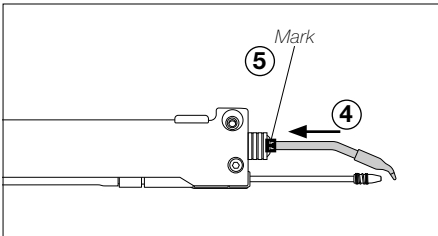

Place a new cartridge into the auto-feed iron (4).

**Important:** For a good connection it is essential to insert the cartridge till the end, until the mark (5).

### 4. Adjusting

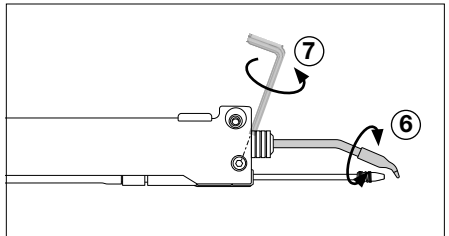

Align the cartridge tip with the guide nozzle (6) and tighten the cartridge screw (7).

## Replacing Guide Sets

Once the tool is disconnected from the control unit and has cooled down, follow these instructions:

Unload the solder wire and disassemble the outlet nozzle (1) from the guide set.

Loosen the guide tube set screw (2), take out the guide set (3) and insert the desired one.

Put the outlet nozzle (1) back on the new guide nozzle. Leave a gap of 5 to 7 mm (0.19 to 0.27 in) between the cartridge tip and the outlet nozzle (4).

Once the guide nozzle length is adjusted tighten the guide set screw (2).

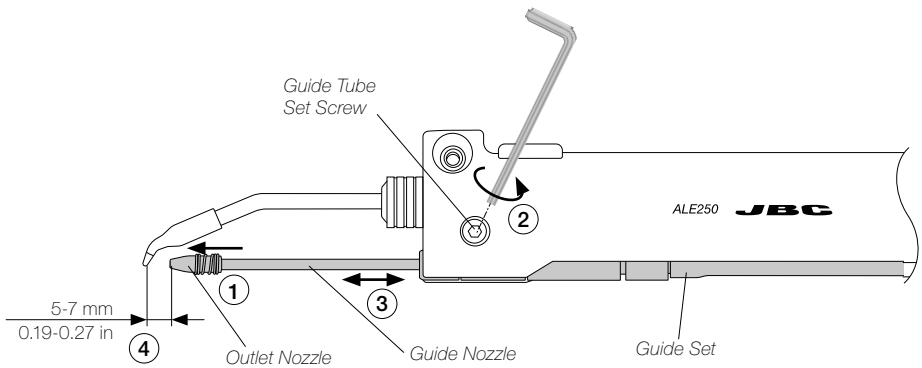

## Wiper

The integrated wiper offers different ways to clean the cartridge tips.

### Tapping

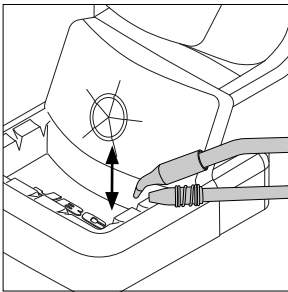

Tap gently to remove excess solder.

### Wiping

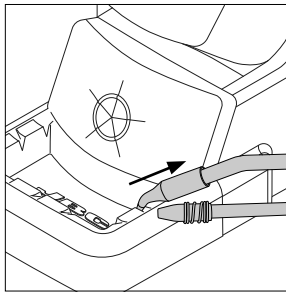

Use the slots to remove the remaining particles.

### Sponge

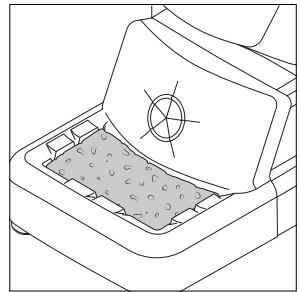

The softest cleaning method. Keep the sponge damp with distilled water when working to avoid tip wear.

## Wiper and Brass Wool Replacement

The wiper and brass wool can easily be removed for cleaning or replacement when they are worn.

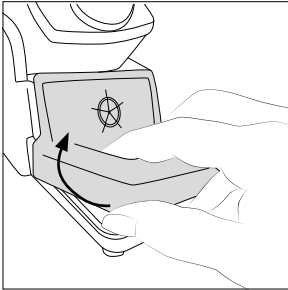

Lift the wiper at its front edge.

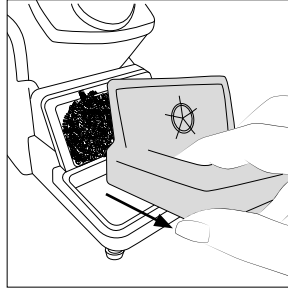

Remove the wiper by pulling it out.

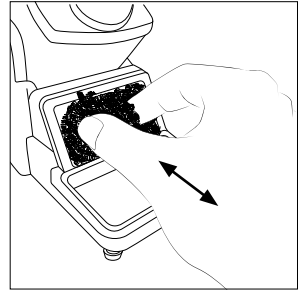

Replace the brass wool with a new one when it is worn out. Place the wiper back or replace them if desired.

## Maintenance

Before carrying out maintenance or storage, always unplug the stand from the station and the tool.

- Use a damp cloth to clean the stand. Alcohol can be used only when cleaning metal parts.
- Check periodically that the metal parts of the tool/stand are clean so that the station can check the tool's status.
- Periodically check all cables and tube connections.
- Replace any defective or damaged parts. Use original JBC spare parts only. Repairs should only be performed by a JBC authorized technical service.

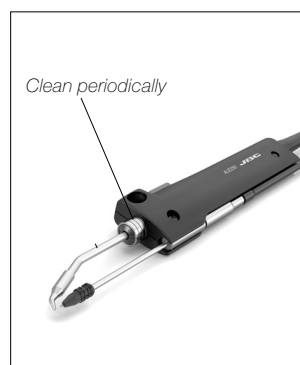
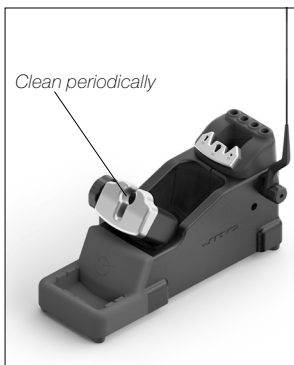

## Safety



**It is imperative to follow safety guidelines to prevent electric shock, injury, fire or explosion.**

- Do not use the stand for any purpose other than soldering or rework.
- The power cord must be plugged into approved bases. Be sure that it is properly grounded before use. When unplugging it, hold the plug, not the wire.
- The tool should be placed in the stand when not in use in order to activate the sleep mode. The soldering tip, the metal part of the tool and the stand may still be hot even when the station is turned off. Handle with care, including when adjusting the stand position.
- Avoid the contact of flux with skin or eyes to prevent irritation.
- Be careful with the fumes produced when soldering.
- Keep your workplace clean and tidy. Wear appropriate protection glasses and gloves when working to avoid personal harm.
- Utmost care must be taken with liquid tin waste which can cause burns.
- This appliance can be used by children over the age of eight and also persons with reduced physical, sensory or mental capabilities or lack of experience provided that they have been given adequate supervision or instruction concerning the use of the appliance and understand the hazards involved. Children must not play with the appliance.
- Maintenance must not be carried out by children unless supervised.







## Specifications

**ALS****Stand for AL250-A Automatic-Feed Soldering Iron**Ref.: **AL-SG****ALES****Stand for ALE250-A Automatic-Feed Soldering Iron**Ref.: **ALE-SA**

For both references:

- |                                               |                                                                 |
|-----------------------------------------------|-----------------------------------------------------------------|
| - Includes                                    | Sleep function                                                  |
| - Total Net Weight                            | 1946 g / 4.29 lb                                                |
| - Package Dimensions / Weight:<br>(L x W x H) | 342 x 155 x 120 mm / 1476 g<br>13.46 x 6.10 x 4.72 in / 3.25 lb |

Complies with CE standards.  
ESD safe.

# JBC

---

## Warranty

JBC's 2 year warranty covers this equipment against all manufacturing defects, including the replacement of defective parts and labor.

Warranty does not cover product wear or misuse.

In order for the warranty to be valid, equipment must be returned, postage paid, to the dealer where it was purchased.

---



This product should not be thrown in the garbage.

In accordance with the European directive 2012/19/EU, electronic equipment at the end of its life must be collected and returned to an authorized recycling facility.



[www.jbctools.com](http://www.jbctools.com)

0027178-141124