

JBC

www.jbctools.com

INSTRUCTION MANUAL



DTS

Stand for DT530

This manual corresponds to the following references:

DT-SA

Packing List

The following items are included:



Stand for DT530 Angled Desoldering Iron 1 unit



Stand Cable 1m 1 unit
Ref. 0024227



Sponge for Modular Tool Stands 1 unit
Ref. S7034



Brass Wool 1 unit
Ref. CL6210



Cable Holder 1 unit
Ref. 0024028
(already assembled)



Manual 1 unit
Ref. 0032551

Features and Connections

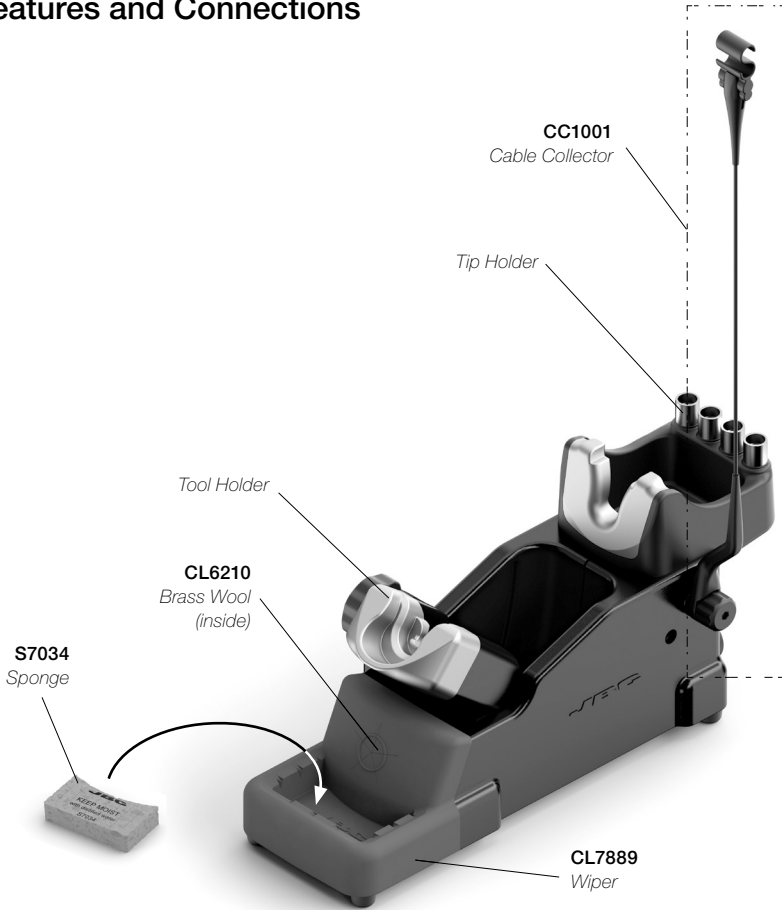

Assembly

Cable Collector (CC1001)

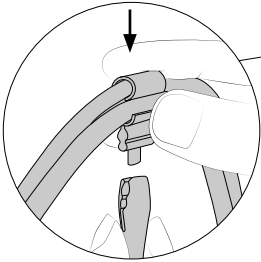

Insert the cable into the clip and then insert into the cable collector. Do not leave the cable longer than necessary to reach the work area freely.

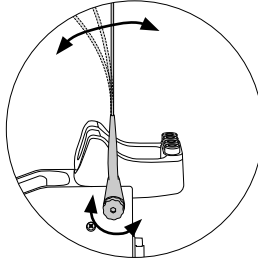

The cable collector is flexible. It accompanies and adapts to the movements during the soldering process.

Tool Holder

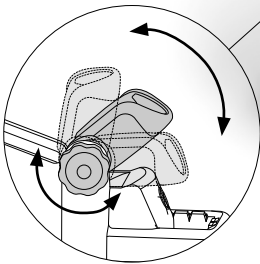

Adjust the tool holder angle to suit the work position.

Wiper (CL7889)

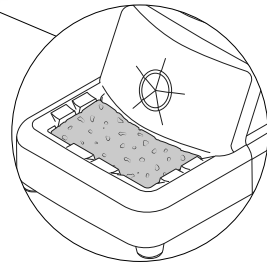

The wiper offers different ways to clean the desoldering tips. If desired use the included sponge.

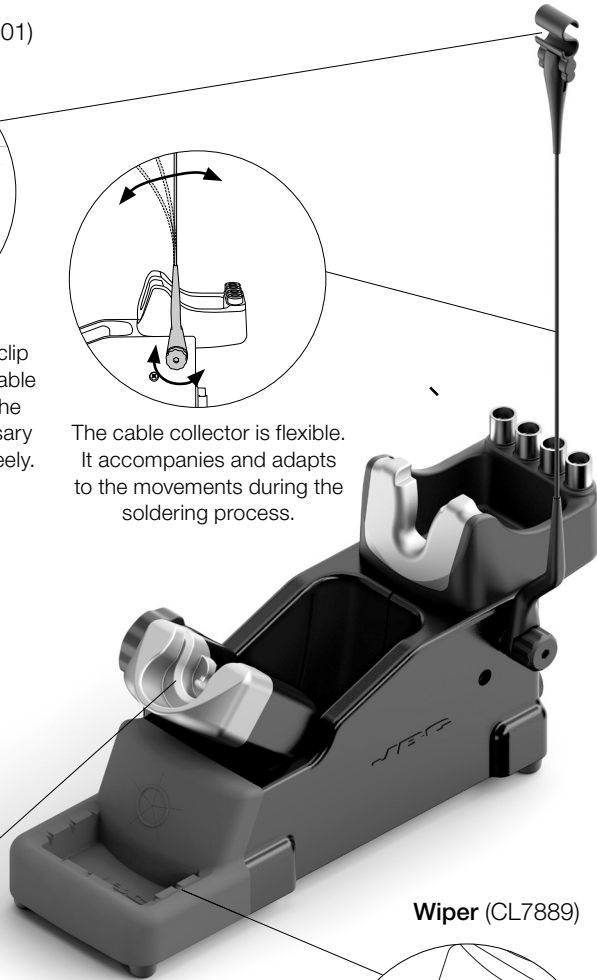

Tip Cleaner

Select the option to suit your needs and improve the thermal transfer of the tip.

CL6210

Brass Wool

Very effective cleaning method. Leaves a small layer of solder on the tip preventing oxidation between cleaning and rewetting.

If the tip is very dirty, JBC recommends first the cleaning with the wiper to remove excess solder.

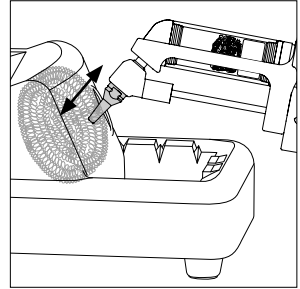

Wiper

The integrated wiper offers different ways to clean the cartridge tips.

Tapping

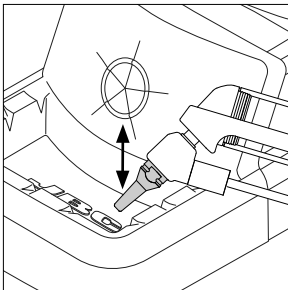

Tap gently to remove excess solder.

Wiping

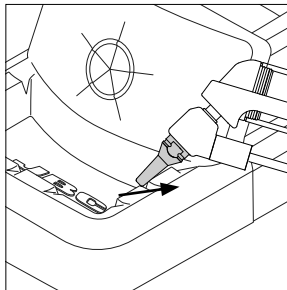

Use the slots to remove the remaining particles.

Sponge

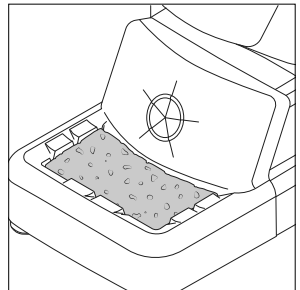

The softest cleaning method. Keep the sponge damp with distilled water when working to avoid tip wear.

Spanner & Tip Storage

The DT50 spanner is used to unscrew and replace the tips.

Spanner Storage

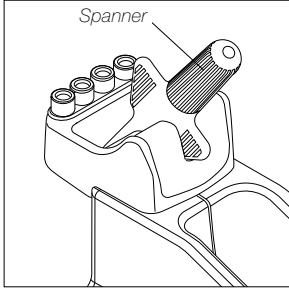

When the spanner is not used, it can be stored on the stand.

Removing Tips

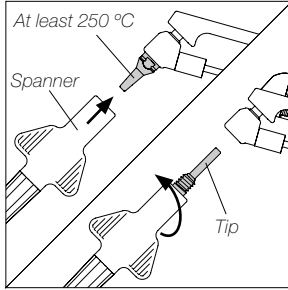

Use JBC's spanner to unscrew the tip. The tip will remain attached to the spanner so that it can be moved safely. To unscrew the tip, it should be hot - at least 250°C.

Tip Storage

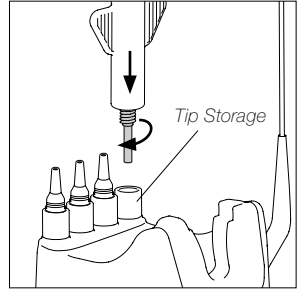

To remove the tip from the spanner, simply place the tip in one of the holes of the tip storage, screw it in lightly (only approx. 1 turn) and pull the spanner out.

Note: Do not screw the tip in too tightly.

Wiper and Brass Wool Replacement

The wiper and brass wool can easily be removed for cleaning or replacement when they are worn. Replacements for Wiper **CL7889** and Brass Wool **CL6210** are available at: www.jbctools.com/cleaning-product-1951.html

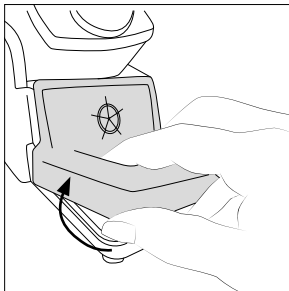

Lift the wiper at its front edge.

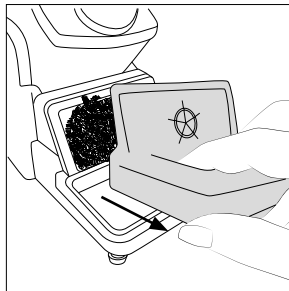

Remove the wiper by pulling it out.

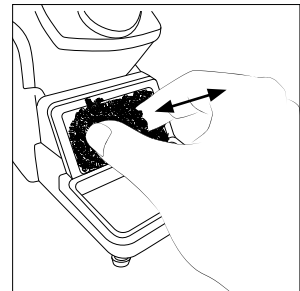

Replace the brass wool with a new one when it is worn out. Place the wiper back or replace them if desired.

Workplace Example*

Connection between stand, tool, filter, module and control unit.

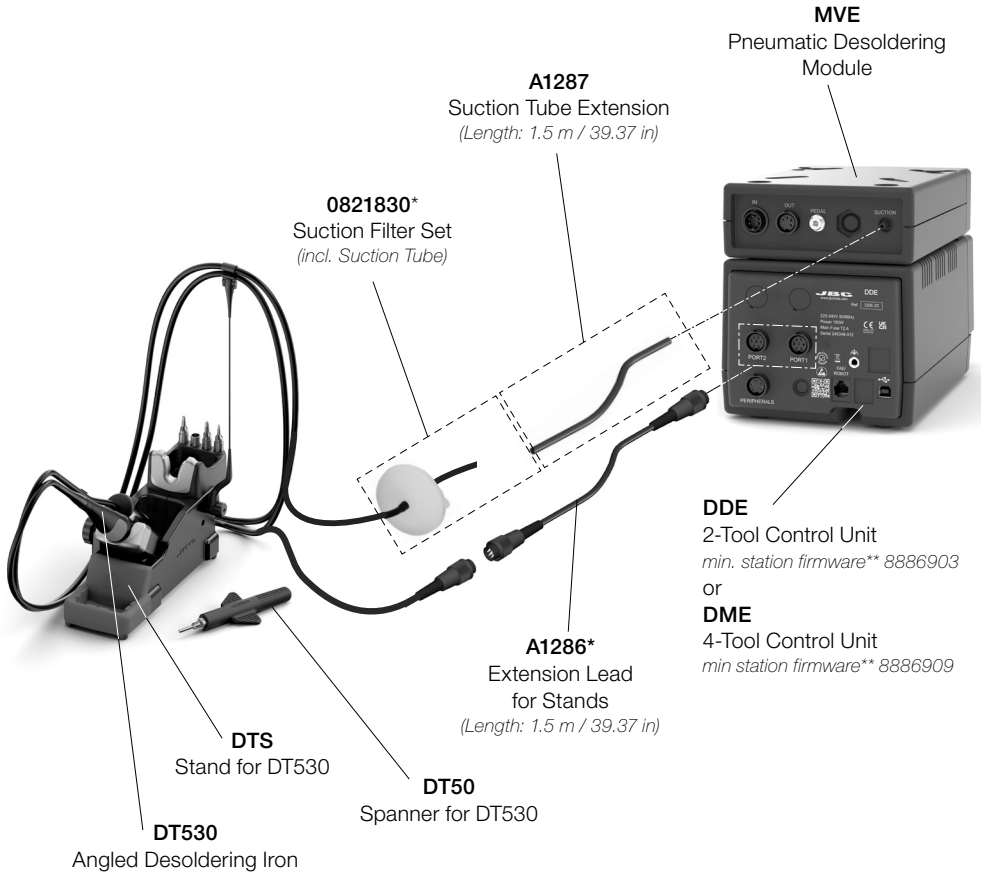

* Not included, sold separately.

** Download from www.jbctools.com/jbcsoftware.html

Maintenance

Before carrying out maintenance or storage, always unplug the stand from the station and the tool.

- Use a damp cloth to clean the stand. Alcohol can be used only when cleaning the metal parts.
- Check periodically that the metal parts of the tool/stand are clean so that the station can check the tool's status.
- Periodically check all cables and tube connections.
- Replace any defective or damaged parts. Use original JBC spare parts only.
- Repairs should only be performed by a JBC authorized technical service.

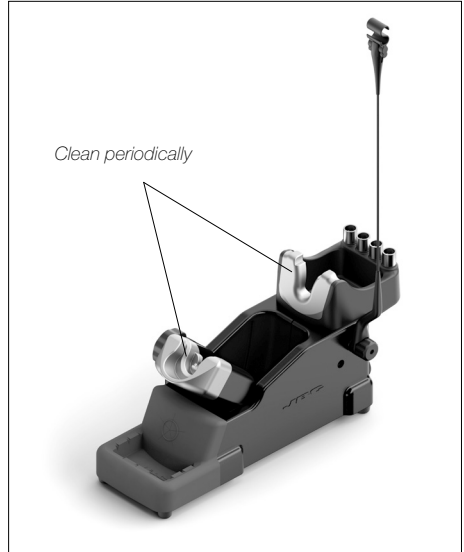

Safety



It is imperative to follow safety guidelines to prevent electric shock, injury, fire or explosion.

- Do not use the stand for any other purpose than desoldering or rework.
- The power cord must be plugged into approved bases. Be sure that it is properly grounded before use. When unplugging it, hold the plug, not the wire.
- The tool should be placed in the stand when not in use in order to activate the sleep mode. The soldering tip, the metal part of the tool and the stand may still be hot even when the station is turned off. Handle with care, including when adjusting the stand position.
- Avoid the contact of flux with skin or eyes to prevent irritation.
- Be careful with the fumes produced when soldering.
- Keep your workplace clean and tidy. Wear appropriate protection glasses and gloves when working to avoid personal harm.
- Utmost care must be taken with liquid tin waste which can cause burns.
- This appliance can be used by children over the age of eight and also persons with reduced physical, sensory or mental capabilities or lack of experience provided that they have been given adequate supervision or instruction concerning use of the appliance and understand the hazards involved. Children must not play with the appliance.
- Maintenance must not be carried out by children unless supervised.

Specifications

DTS

Stand for DT530 Angled Desoldering Iron

Ref.: DT-SA

- | | |
|---|---|
| - Sleep and Hibernation Modes: | Included |
| - Total Net Weight: | 1.7 kg / 3.76 lb |
| - Package Dimensions/Weight: (L x W x H) | 340 x 160 x 120 mm / 2.12 kg 13.39 x 6.30 x 4.72 in / 4.67 |

Complies with CE standards
ESD safe

JBC

Warranty

JBC's 2 year warranty covers this equipment against all manufacturing defects, including the replacement of defective parts and labor.

Warranty does not cover product wear or misuse.

In order for the warranty to be valid, equipment must be returned, postage paid, to the dealer where it was purchased.



This product should not be thrown in the garbage.

In accordance with the European directive 2012/19/EU, electronic equipment at the end of its life must be collected and returned to an authorized recycling facility.



www.jbctools.com