

# JBC

[www.jbctools.com](http://www.jbctools.com)

## INSTRUCTION MANUAL



# JTSE

Power Hot Air Control Unit

This manual corresponds to the following references:

**JTSE-9UA** (100 V)

**JTSE-1UA** (120 V)

**JTSE-2UA** (230 V)

## Packing List

The following items are included:



**Power Hot Air Control Unit** ..... 1 unit

**Power cable** ..... 1 unit

Ref. 0024099 (100V)

0023715 (120V)

0023714 (230V)

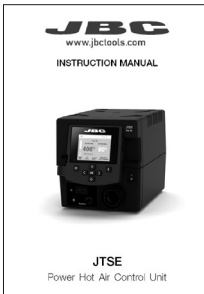

**Manual** .....1 unit

Ref. 0027698

*Other languages available on [www.jbctools.com](http://www.jbctools.com).*

## Features and Connections



\* not included

# JTSE / TESE Work Screen

The work screen offers an **intuitive user interface** which provides **quick access** to station parameters. **Default PIN: 0105**

The screenshot shows the JBC work screen with the following data and labels:

- Status Bar:** Includes a speaker icon, the time 19:29, and a 'Time to Stop' indicator of 4m 38s.
- Instant Power Supplied to Heater:** Represented by a vertical bar on the left side of the screen.
- Current Air Temp.:** Displayed as 400°C.
- Selected Air Temp.:** Displayed as 400°C Selected.
- Current External TC Temp.:** Displayed as 20°C.
- Selected External TC Temp.:** Displayed as 120°C Selected.
- Air Flow:** Displayed as 80%.
- Protection:** Displayed as 120°C Selected.
- Power:** Displayed as 45%.
- Hot Air Temp.:** Labeled as 'Hot Air Temp.'.
- Air Flow Selec.:** Labeled as 'Air Flow Selec.'.

The navigation keypad consists of the following buttons:

- Up arrow
- Down arrow
- Left arrow
- Right arrow
- OK button
- Information icon (i)
- Menu icon (three horizontal lines)

## Menu Options

	<p>Set the station parameters</p>		<p>Set the tool parameters</p>		<p>Display the hours worked in each cycle</p>
<p><b>Station</b></p>		<p><b>Tools</b></p>		<p><b>Counters</b></p>	
	<p>It is possible to choose the language from a list.</p>		<p>Allows you to carry out an overall station reset restoring all the parameters to their default values.</p>		
<p><b>Language</b></p>		<p><b>Reset</b></p>			

## Troubleshooting

Station troubleshooting available on the product page at [www.jbctools.com](http://www.jbctools.com)

## Advanced Functionalities



### Profiles

To work with profiles it is essential to use RWB / RWS / RWT rework arms. The Rework Arms supports the Hot Air Heater maintaining the distance and position to the component.

In this mode you can **set up or edit** as many as 25 air flow and temperature profiles.

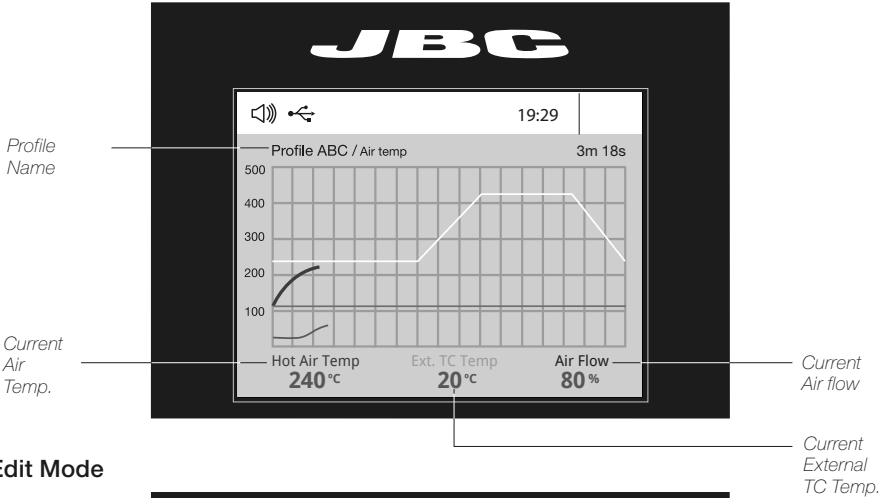

### Edit Mode

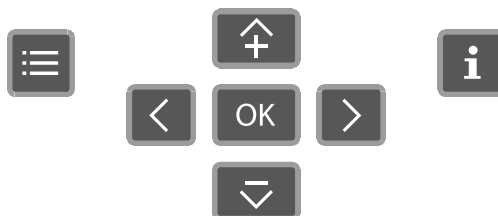
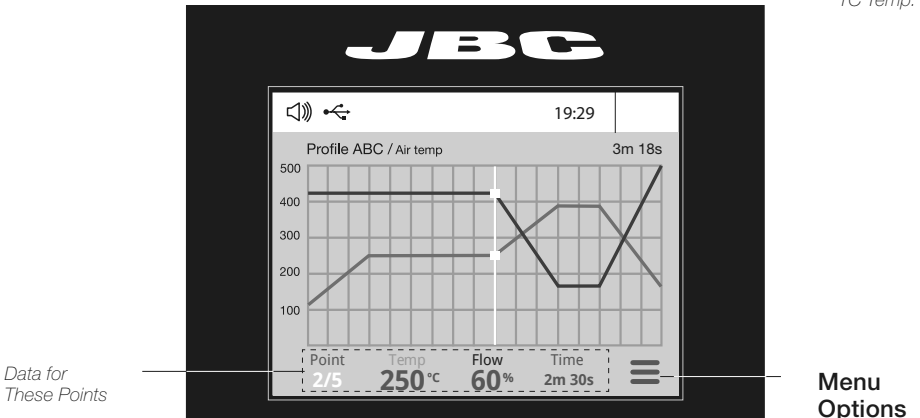

### Menu Options

- Add point
- Delete point
- Load profile
- Save profile
- Exit



Graphics

By pressing **Graphics** in the main MENU, temperature and power figures in real time are displayed. This helps you decide which nozzle to use to obtain the best quality solder joints.

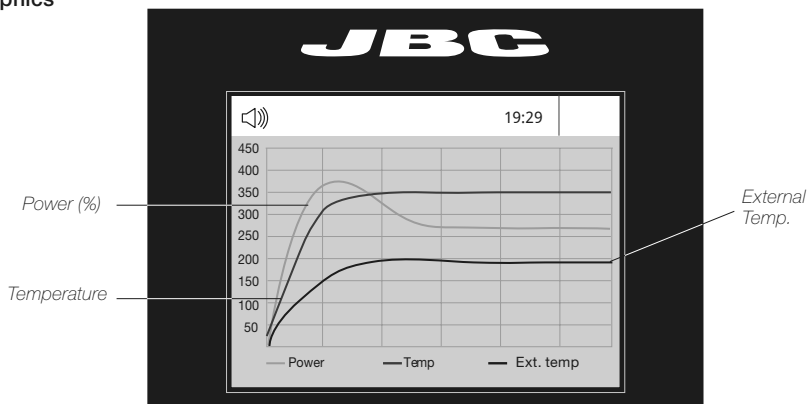

Files

### Export Graphics

Insert a USB flash drive into the USB-A connector to save your soldering process in csv format.



Update

### Station Update

Download the JBC Update File from [www.jbctools.com/software.html](http://www.jbctools.com/software.html) Insert the USB flash drive with the file downloaded to the station.

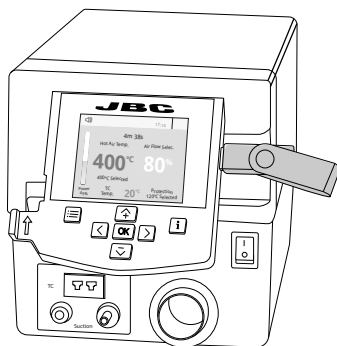

## System Notifications

The following icons will be displayed on the screen's status bar.



USB flash drive is connected.



Station software update.  
Press INFO to start the process.



Station is controlled by a PC.



Warning.  
Press INFO for failure description.



Station is controlled by a robot.



Error.  
Press INFO for failure description, the type of error and how to proceed.

## Adjustable Tool Holder

Adjust the tool holder angle to suit your work position.

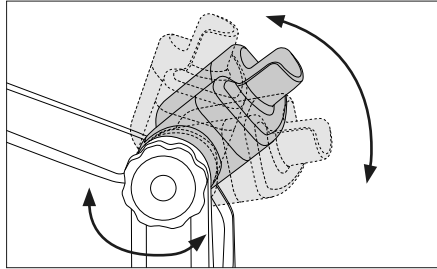

### Operation Modes

1. From the Tool Settings Menu, select the mode to activate the tool depending on the task.

#### Tool button

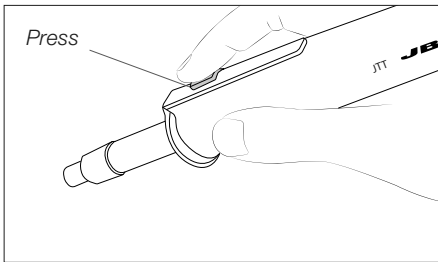

Press the start/stop button to blow hot air.

#### Pedal (not included)

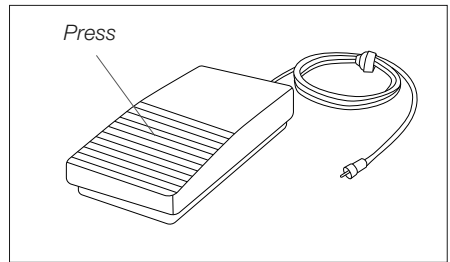

Press the Pedal P405 to blow hot air and release it to stop.

2. The tool stops blowing when pressing the start/stop button.

If the stand is connected to the station and for safety reasons, it will also stop when returned to the stand.

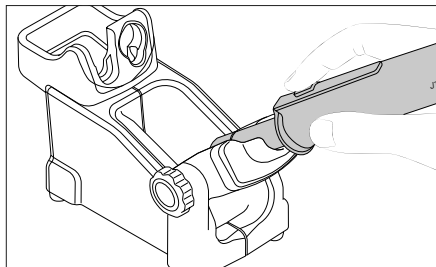

# Operation

## 1. Placing

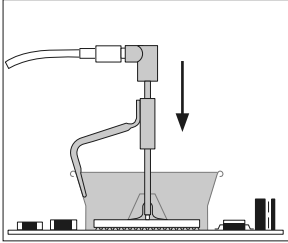

Position the extractor with the appropriate suction cup and press the suction button.

## 2. Heating

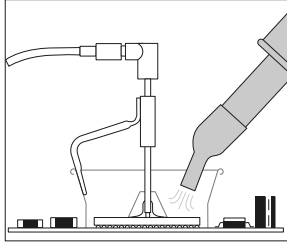

Heat the component.

## 3. Extracting

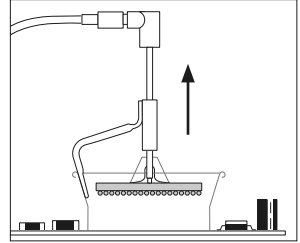

The component lifts off automatically when the solder melts.

# Protectors & Extractors

**For small components** (fig. 1 and 2).

We recommend using the protector + tripod

**For large components** (fig. 3 and 4).

We recommend using the manual extractors

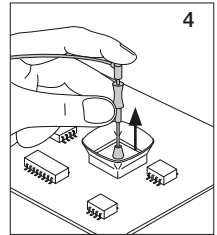
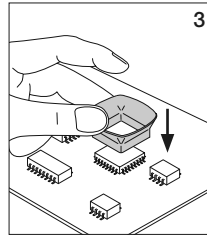
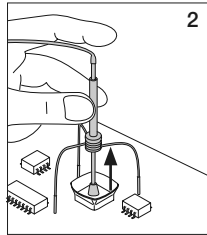
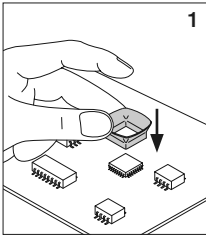



**Accessories** *(not included)*

**Protectors**



No.*	Ref.	AxB (mm)	AxB (in)	No.*	Ref.	AxB (mm)	AxB (in)
	<b>P3353</b>	4,3 x 3	0.16 x 0.12		<b>P1249</b>	12 x 23	0.47 x 0.9
	<b>P3786</b>	5,2 x 5,2	0.20 x 0.20	44	<b>P4000</b>	12,5 x 12,5	0.49 x 0.49
	<b>P3352</b>	5,2 x 7,5	0.20 x 0.29		<b>P3354</b>	13,2 x 13,2	0.52 x 0.52
	<b>P3355</b>	5,2 x 9,5	0.20 x 0.37		<b>P4025</b>	13,5 x 21,5	0.53 x 0.85
	<b>P3356</b>	6,2 x 4,2	0.24 x 0.16	48	<b>P2230</b>	15 x 15	0.59 x 0.59
	<b>P3785</b>	7,2 x 7,2	0.28 x 0.28	60	<b>P4010</b>	17 x 17	0.67 x 0.67
	<b>P3784</b>	8,2 x 8,2	0.32 x 0.32		<b>P4005</b>	18 x 29	0.71 x 1.14
	<b>P4035</b>	9 x 13	0.35 x 0.51		<b>P4030</b>	18,5 x 18,5	0.73 x 0.73
	<b>P4040</b>	9,5 x 19	0.7 x 0.74		<b>P1068</b>	18,5 x 24	0.73 x 0.94
	<b>P4080</b>	9,5 x 21	9.5 x 0.83		<b>P2685</b>	28,5 x 28,5	1.12 x 1.12
32	<b>P2220</b>	10 x 10	0.39 x 0.39		<b>P4085</b>	31,5 x 31,5	1.24 x 1.24
	<b>P4045</b>	10,5 x 21	0.14 x 0.82		<b>P2672</b>	33 x 46	1.30 x 1.18
	<b>P4090</b>	11 x 16	0.43 x 0.63		<b>P4002</b>	50 x 50	1.97 x 1.97
24	<b>P2235</b>	12 x 17	0.47 x 0.67		<b>P3357</b>	52,5 x 14	2.06 x 0.55

**Extractors**



No.*	Ref.	AxB (mm)	AxB (in)	No.*	Ref.	AxB (mm)	AxB (in)
52	<b>E2052</b>	20 X 20	0.79 x 0.79		<b>E4015</b>	31,5 X 31,5	1.24 x 1.24
64	<b>E2064</b>	20 X 26	0.79 x 1.02		<b>E2084</b>	33 X 33	1.30 x 1.30
80	<b>E2184</b>	24 X 24	0.94 x 0.94		<b>E2100</b>	38 X 38	1.50 x 1.50
	<b>E2068</b>	27 X 27	1.06 x 1.06		<b>E2124</b>	45 X 45	1.77 x 1.77
	<b>E4020</b>	28,5 X 28,5	1.12 x 1.12				

**Tripods**

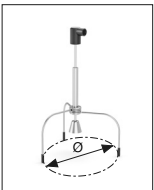

Ref.	øC (mm)	øC (in)
<b>T2050</b>	39	1.53
<b>T2250</b>	85	3.35

**Manual Extractor**



Ref.	øD (mm)	øD (in)
<b>E2190</b>	7	0.27

\* Corresponding number on ESHT and supplied in it.

# Using the Thermocouple Type K

Connect a TC type K (PH218) to the station and use it as a protection or regulation sensor. You can define its use mode by means of the “Ext TC mode” option in the “Tool” menu.

You can choose from **two work modes**:

**Regulation:** the station regulates the air the temperature automatically to maintain the External Thermocouple (TC) temperature.

**Protection:** the station cuts the air supply off when the External Thermocouple (TC) temperature is reached.

*Fix the TC with Kapton Tape (Ref. PH217) as near as possible to the component being worked on. If Kapton tape is not ESD you must use an ionizer.*

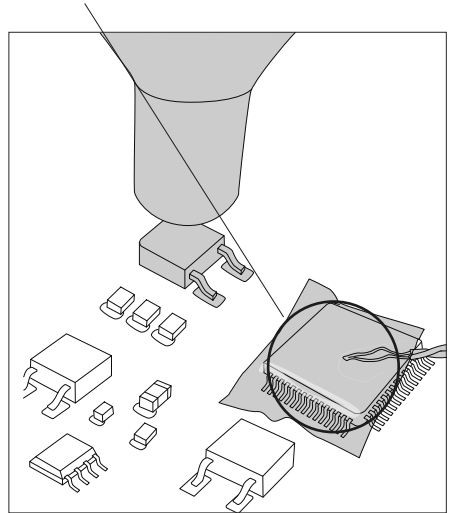
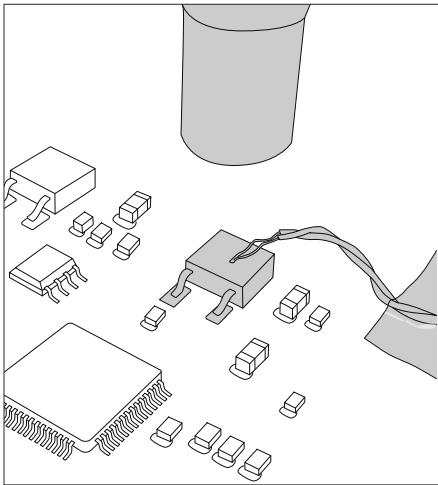

It is not recommended to exceed ramp-up rates over 3-4 °C / sec. (5-7 °F / sec) so as to reduce the risk of thermal stress on the PCB.

## Nozzle Exchanger

⚠ Turn the tool off and handle with care. The heating element and the nozzle are still hot.

### 1. Removing Nozzle

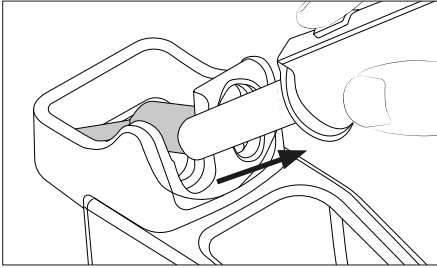

Place the heating element with its nozzle in the nozzle changer and pull the tool to remove it. The nozzle comes to rest in the nozzle holder.

### 2. Attaching Nozzle

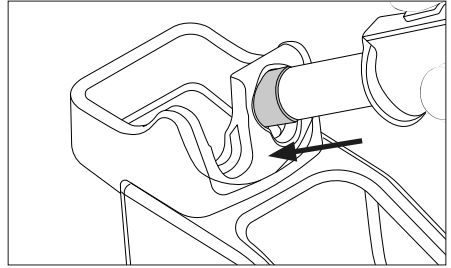

Attach the nozzle and press the nozzle onto the heating element with the help of the opening in the nozzle exchanger.

## Compatible Nozzles

JTT works with JN nozzles. Find the model that best suits your soldering needs at [www.jbctools.com](http://www.jbctools.com)

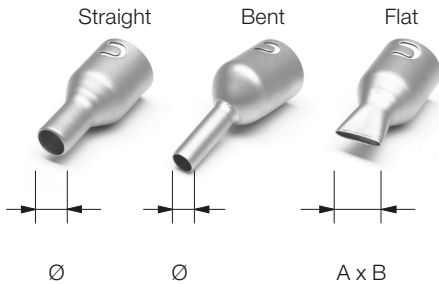

In case of a loosely fitting nozzle:

1. Push the nozzle tab inwards with a screwdriver or flat-nosed pliers.

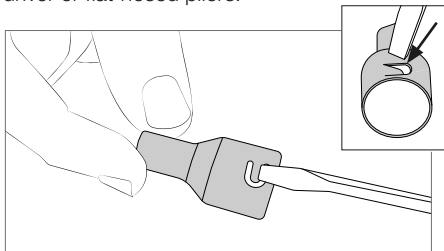

2. Assemble the nozzle onto JTT again.

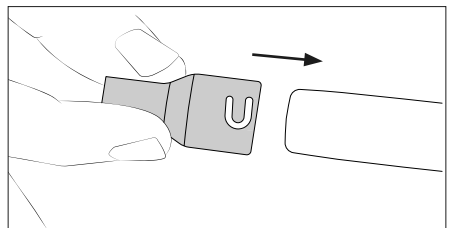

*	Ref.	Shape	Size (mm)	Size (in)
*	JN2020	Straight	Ø 8	Ø 0.31
	JN8417	Straight	Ø 10	Ø 0.4
*	JN2015	Bent	Ø 4	Ø 0.16
*	JN2012	Bent	Ø 6	Ø 0.24
	JN6633	Bent	Ø 8	Ø 0.31
	JN7637	Flat	10 x 2	0.39 x 0.08
	JN7638	Flat	20 x 2	0.79 x 0.08
	JN7639	Flat	30 x 2	1.18 x 0.08

\* Supplied with JTSE Station

## Replacing the Heating Element

**Note:** Only perform this operation when the element is cold and the unit is disconnected from the mains.

Loosen the screw (1) and pull the worn heating element out of the handle (2).

Insert the new heating element, make sure its pushed all the way in (2) and tighten the screw (1).

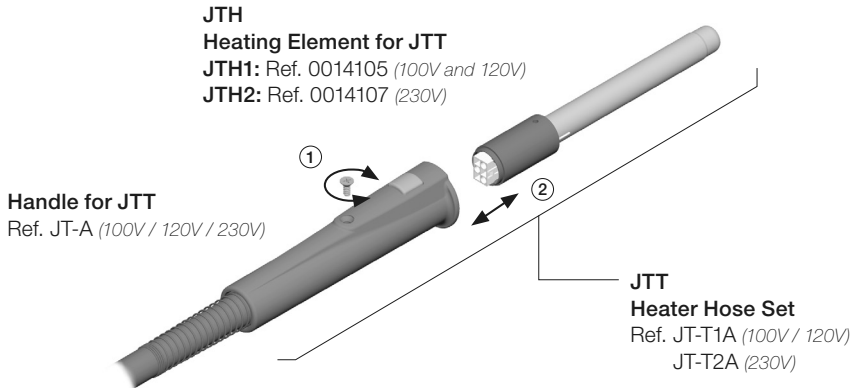

## Changing the JTT Heater Hose Set

**Note:** Only perform this operation when the station is turned off.

Use a spanner to unscrew the nut (1) and remove the tool hose from the control unit (2).

Insert the new hose, make sure it is pushed all the way into the connector (2), and tighten the nut (1).

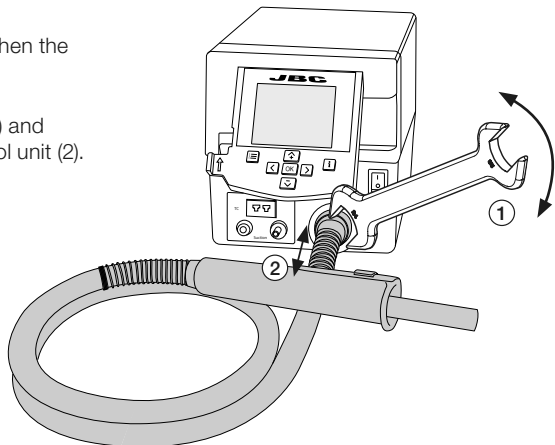

## Maintenance

Before carrying out maintenance, always allow the equipment to cool.

- Clean the station screen with a glass cleaner or a damp cloth.
- Use a damp cloth to clean the casing and the tool. Alcohol can only be used to clean the metal parts.
- Periodically check that the metal parts of the tool and stand are clean so that the station can detect the tool's status.
- Periodically check all cables and tubes.
- Replace a blown fuse as follows:



**1.** Pull off the fuse holder and remove the fuse. If necessary use a tool to lever it off.

**2.** Insert the new fuse into the fuse holder and return it to the station.

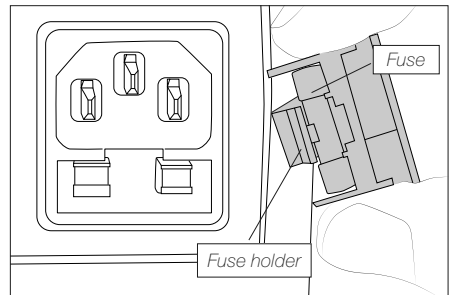
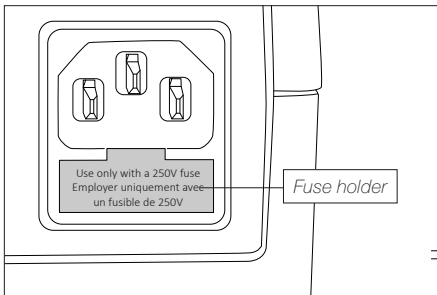

- Replace any defective or damaged pieces. Use original JBC spare parts only.
- Repairs should only be performed by a JBC authorized technical service.

# Safety



**It is imperative to follow safety guidelines to prevent electric shock, injury, fire or explosion.**

- Do not use the units for any purpose other than soldering or rework. Incorrect use may cause a fire.
- The power cord must be plugged into approved bases. Be sure that it is properly grounded before use. When unplugging it, hold the plug, not the wire.
- Do not work on electrically live parts.
- The tool should be placed in the stand when not in use in order to activate the sleep mode. The soldering tip or nozzle, the metal part of the tool and the stand may still be hot even when the station is turned off. Handle with care, including when adjusting the stand position.
- Do not leave the appliance unattended when it is on.
- Do not cover the ventilation grills. Heat can cause inflammable products to ignite.
- Avoid flux coming into contact with skin or eyes to prevent irritation.
- Be careful with the fumes produced when soldering.
- Keep your workplace clean and tidy. Wear appropriate protection glasses and gloves when working to avoid personal harm.
- Utmost care must be taken with liquid tin waste which can cause burns.
- This appliance can be used by children over the age of eight and also people with reduced physical, sensory or mental capabilities or lack of experience provided that they have been given adequate supervision or instruction concerning the use of the appliance and understand the hazards involved. Children must not play with the appliance.
- Maintenance must not be carried out by children unless supervised.











## Specifications

### JTSE

#### Power Hot Air Control Unit

Ref.: **JTSE-9UA** 100V 50/60Hz. Input fuse T8A. Rated current 7A.

Ref.: **JTSE-1UA** 120V 50/60Hz. Input fuse: T8A. Rated current: 7A.

Ref.: **JTSE-2UA** 230V 50/60Hz. Input fuse: T4A. Rated current: 3A.

- Nominal Power: 700 W
- Selectable Temperature: 150 - 450 °C / 300 - 840 °F / Room temp.
- Cool Mode: T off. Used to blow air to room temperature
- Ambient Operating Temp.: 10 - 50 °C / 50 - 122 °F
- Air Flow Regulation: 5 - 50 SLPM
- Vacuum: 30% / 228 mmHg / 9 inHg
- Connectors: USB-B  
RJ-12  
P-005 Pedal
- Control Unit Dimensions/Weight:  
(L x W x H) 1.90 kg / 4.2 lb  
230 x 148 x 160 mm / 9.06 x 5.83 x 6.30 in
- Total Package Dimensions/Weight:  
(L x W x H) 258 x 328 x 208 mm / 2.56 kg  
10.15 x 12.91 x 8.19 in / 5.64 lb

Complies with CE standards.  
ESD safe.

# JBC

---

## Warranty

JBC's 2 year warranty covers this equipment against all manufacturing defects, including the replacement of defective parts and labor.

Warranty does not cover product wear or misuse.

In order for the warranty to be valid, equipment must be returned, postage paid, to the dealer where it was purchased.

**Get 1 extra year JBC warranty by registering here:**  
**<https://www.jbctools.com/productregistration/>**  
**within 30 days of purchase.**

If you register, you will receive e-mail notifications about new software updates for your registered product.

---



This product should not be thrown in the garbage.

In accordance with the European directive 2012/19/EU, electronic equipment at the end of its life must be collected and returned to an authorized recycling facility.

CE EAC UK  
CA

[www.jbctools.com](http://www.jbctools.com)

0027698-140125