

JBC

www.jbctools.com

Product
website



INSTRUCTION MANUAL

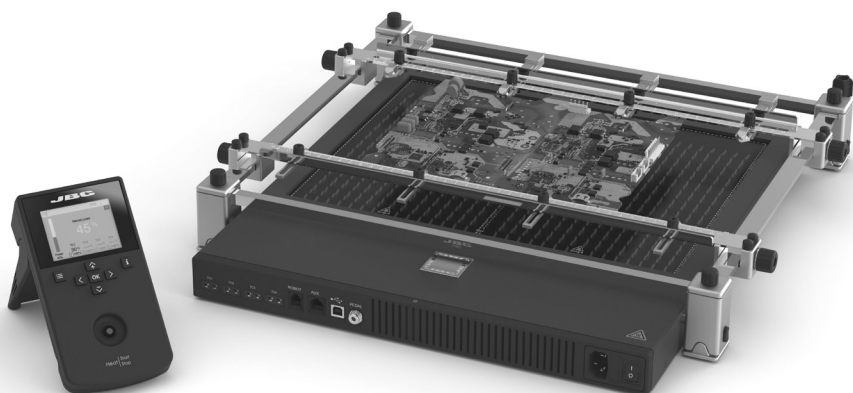

PHBEK

Preheater Set for PCBs
up to 36x28cm/14x11"

This manual corresponds to the following references:

PHBE-9KB (100 V)

PHBE-1KB (120 V)

PHBE-2KB (230 V)

Packing List

The following items are included:



PHBE Preheater Unit 1 unit

PHBS Support 1 unit
Ref. PHB-SA



Console 1 unit
Ref. ACE-A



RJ45 Cable 1 unit
Ref. 0019914



Power Cord1 unit
Ref. 0030177 (100 V)
0030093 (120 V)
0030175 (230 V)



Kapton Tape 1 unit
Ref. PH217



Thermocouple 2 unit
Ref. PH218



Manual 1 unit
Ref. 0029844

Features and Connections

Preheater Unit

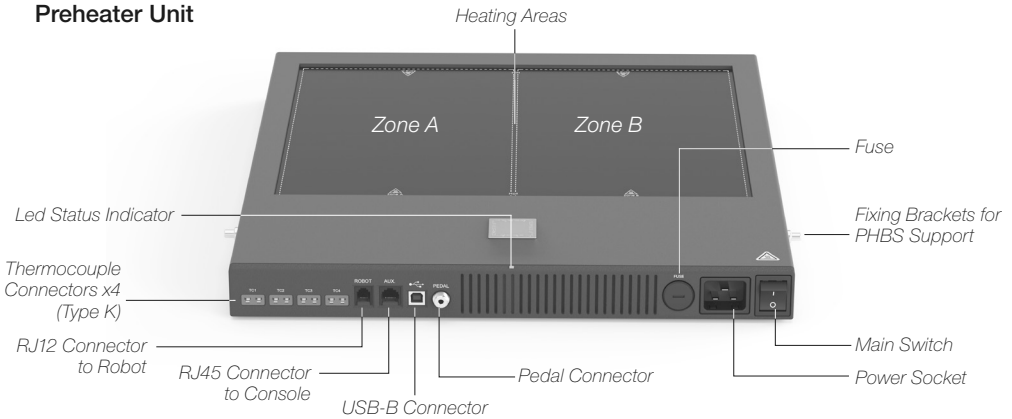

Console

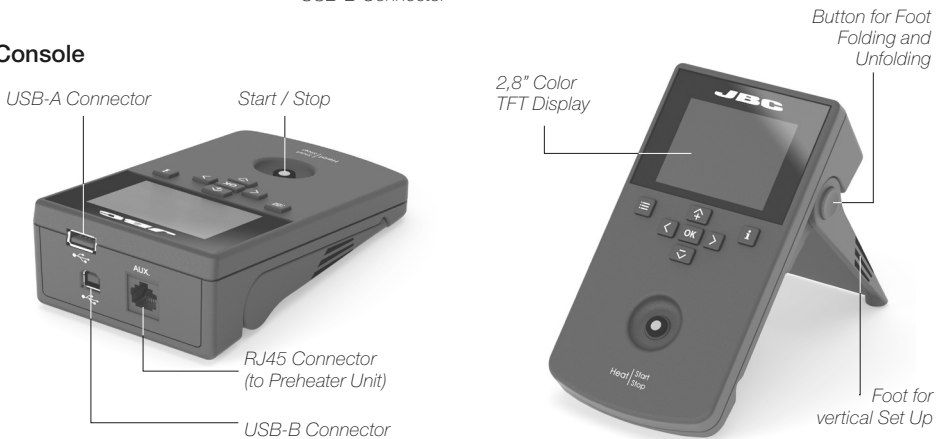

Support

Max. PCB Dimension (between clamps):
36x28 cm / 14x11 in, Thickness 6 mm / 0.236 in

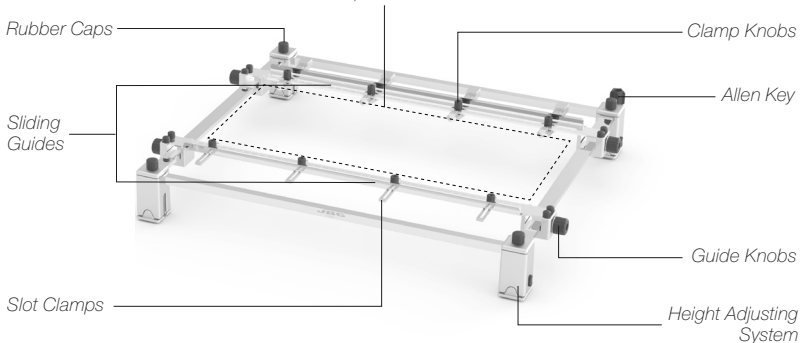

Placement Instructions

⚠ The equipment must be installed on a flat surface without any deformation. An uneven surface, either caused by its own weight or by the weight of the preheater or support, can lead to damage to the equipment.

Height Adjustment

PHBS support allows adjustment for **3 heights** between the PCB and the Heating Area of the Pre-heater Unit. To change the height, do as follows:

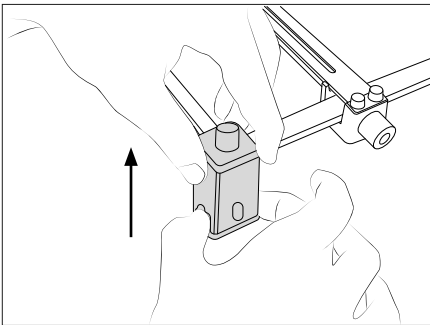

To raise the support, hold the base and pull up.

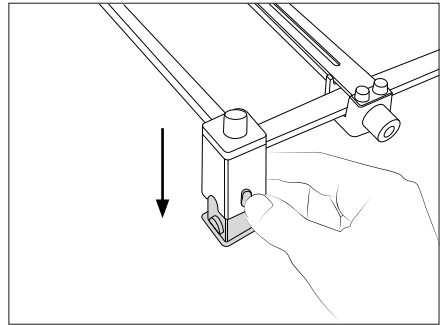

To lower the support, press the button and push down.

Choose one of the **3 positions** to suit your working needs.

Low level
28 mm

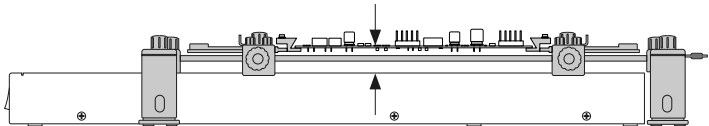

Medium level
38 mm

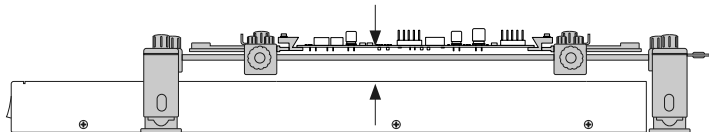

High level
48 mm

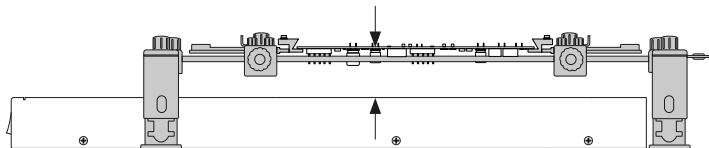

Fast PCB Replacement

The support lets you replace PCBs of the same batch fast and easily thanks to the spring-loaded clamps, located at the frontal sliding guide. To do this, there is no need to open the sliding guide knob (1) and nor to move the sliding guides.

Removing the PCB

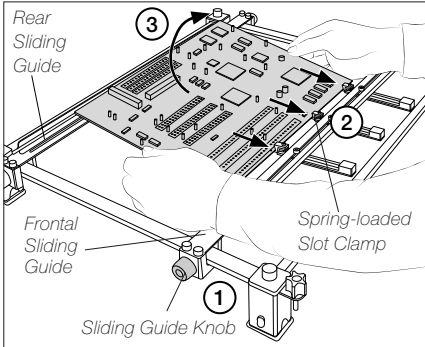

Push the PCB towards you and against the spring-loaded slot clamps (2).

Then remove the opposite side of the PCB from the clamps on the rear sliding guide (3).

Placing another PCB

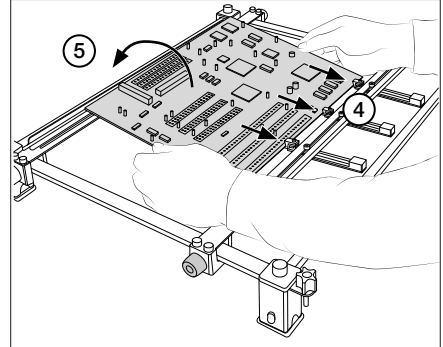

Fit the new PCB into the spring-loaded clamps at the frontal sliding guide, push the PCB towards you (4) to gain enough space to fit the opposite side of the PCB into the clamps on the rear sliding guide (5).

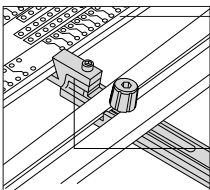

Max. PCB dimension
(between clamps):
36x28 cm / 14x11 in
thickness 6 mm / 0.236 in

Spring-loaded slot
clamps allow PCB
fixation and easy PCB
replacement

The PCB will be automatically held in place by the force of the spring-loaded clamps.

Reworking large PCBs

Use the 4 rubber caps to place PCBs larger than the support or thicker than 3mm. To ensure that the guides do not collide with the PCB, they must be removed first.

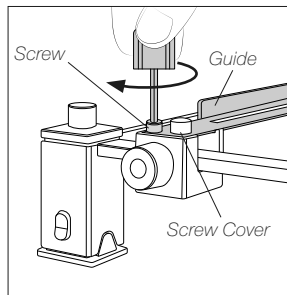

First remove the screw covers and then the screws. Then remove both guides.

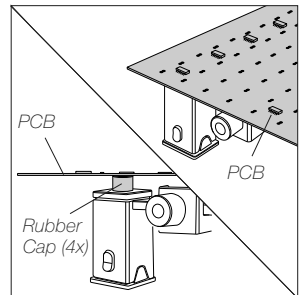

Place the PCB on the 4 rubber caps and the PCB is ready to work.

Status Indicator

The led status indicator indicates as follows the status of the preheater:

Blue:

The unit is resting, not heating. On the display, the symbol  “Stop” (1) is shown.

Green:

The unit is running and heating accordingly to the operating mode. On the display, the symbol  “Play” (2) is shown.

Red:

The unit has stopped after having finished a heating cycle. The red light indicates that the glass of the heating unit may be hot. After cooling down, the LED turns **blue** and the symbol  “Stop” (1) appears on the display.

Flashing red:

An error has occurred. The console display indicates the error type.



Led status indicator

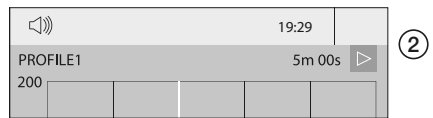
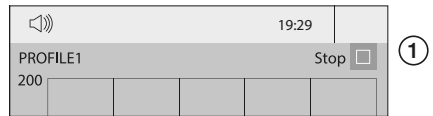

Main Menu

After switching on the preheater, the main menu can be accessed by pressing the menu button on the console.

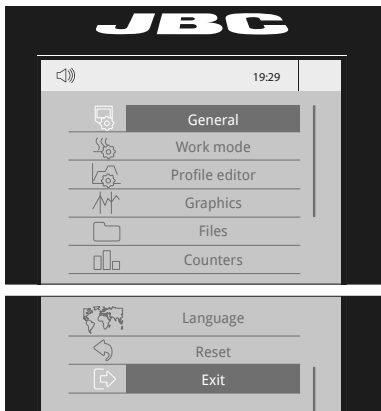

Move upwards, downwards and sideways within the menu options. Press OK to confirm selection.

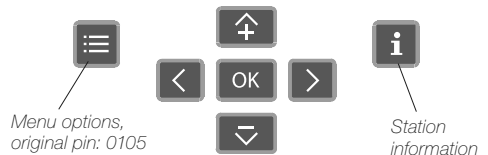

Menu options, original pin: 0105

Station information



General



Work mode



Profile editor



Graphics

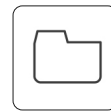

Files



Reset

Available menu languages: English, Spanish, German, French, Italian, Portuguese, Japanese, Chinese, Russian and Korean.





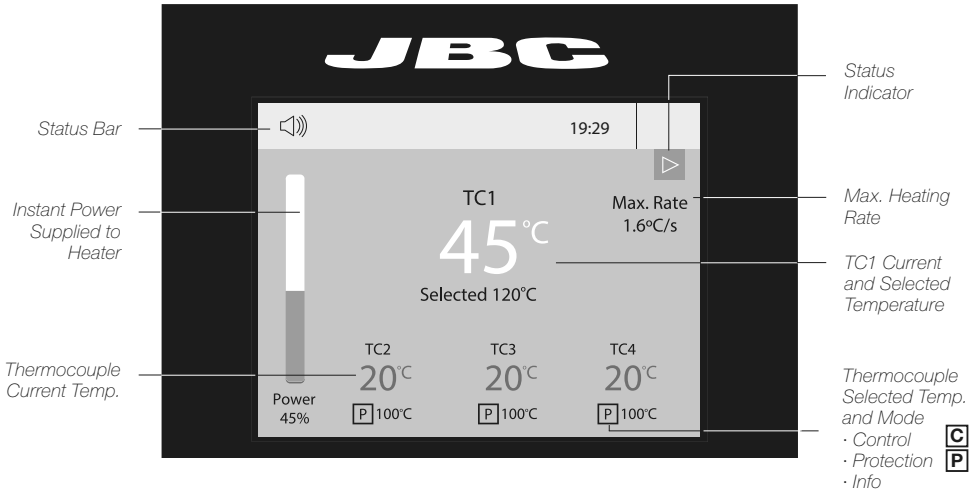

Work Display

The console offers an intuitive user interface, which provides quick access to station parameters.



System Notifications (Status Bar)

The following icons can be displayed on the status bar.

-  USB flash drive is connected.
-  Device is controlled by a PC.
-  Device is controlled by a robot.
-  Beep of the buttons is on.
-  Device software update. Press INFO to start the process.
-  Warning. Press INFO for failure description.
-  Error. Press INFO for failure description, the type of error and how to proceed.

Troubleshooting

Station troubleshooting is available on the product page on www.jbctools.com.

Setting Thermocouples Function

Select *Thermocouples* from the *Work mode* menu to set them up. The thermocouples (TC) can work in three different ways depending on what is needed.

- C** · Control: the unit maintains the selected temperature.
- P** · Protection: the Heater Unit stops if the TC reaches the selected temperature.
- Info: the TC temperature is shown on the work display.

The TC1 is always working in Control mode for the Temperature mode as well as for Profiles mode. The temperature of each TC can also be selected from the work display.

Recommended Guidelines

1. Place the control thermocouple as near as possible to the component being worked on.
2. If there are any sensitive components, use a thermocouple as protection.
You can select the protection temperature in the *thermocouples* menu. If the selected temperature is reached, the Heater Unit will stop the process and a warning message will be shown.

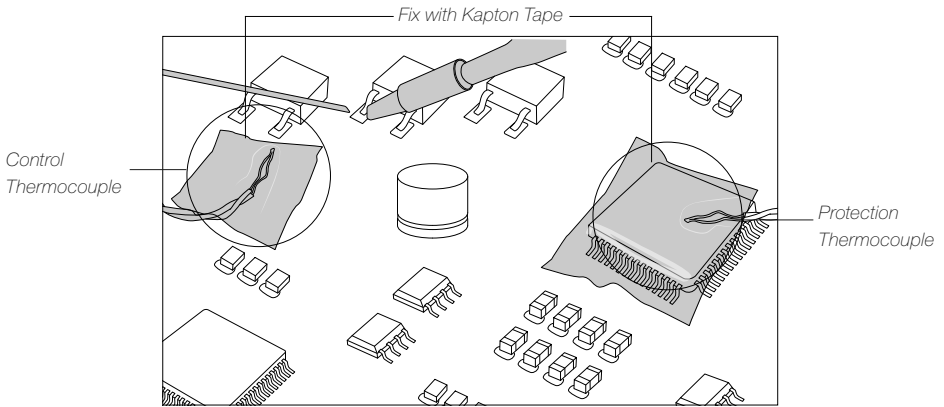

3. We don't recommend exceeding ramp-up rates over 3 - 4 °C / sec (5 - 7 °F / sec) so as to reduce the risk of thermal stress on the PCB.

Work Mode

Temperature Mode:

Select *Temp. mode* from the *Work mode* menu. In this mode, the heater unit maintains the selected temperature for the TC1 thermocouple as long as the other TC's do not reach the control/protection temperature limit.

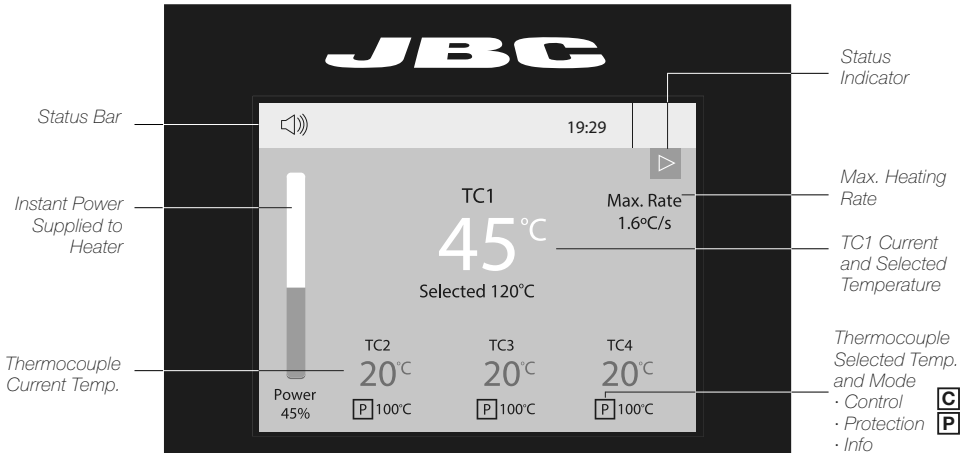

Working within the Temperature Mode the maximum heating rate value (*Max Rate*) can be defined (1).

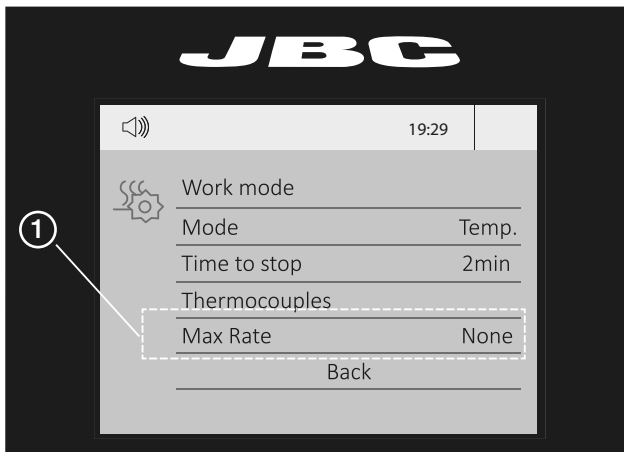

This function allows you to set a maximum value for the temperature increase per second when heating.

The maximum heating rate value can be set between 0.1°C/s and 2.0°C/s (2) or “None” if this function is not desired.

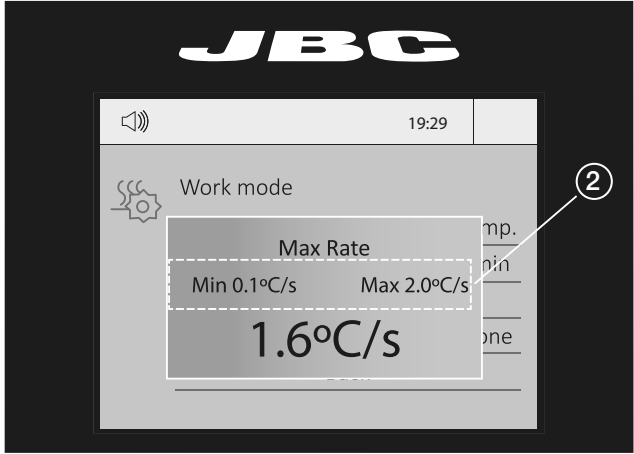

Power Mode:

Select *Power mode* from the *Work mode* menu. In this mode, the heater unit maintains the selected power as long as the thermocouples do not reach the control/protection temperature limit.

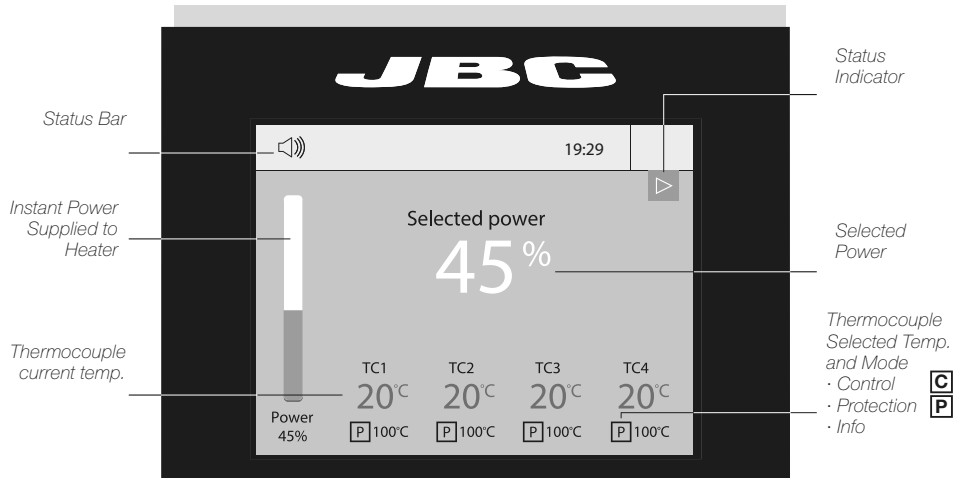

Profile Modes

Select *Profile Mode* from the *Work Mode* Menu. In this mode the heater unit regulates the temperature of the TC1 thermocouple according to the selected profile as long as the other TCs do not reach the control/protection temperature limit.

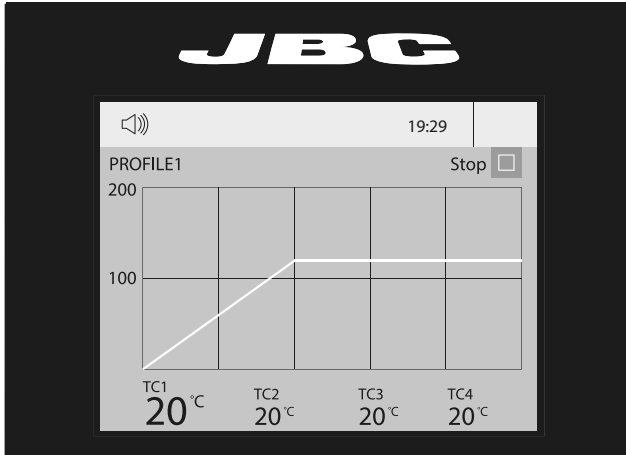

Teach Profile

For repetitive jobs it is also possible to run customized profiles without the thermocouple (TC). In order to do so, the *Teach profile* mode has to be executed before running any profile. It can be executed from the *Work mode* menu if the *Profiles* mode is selected. The first time, the thermocouple must be connected. Once the profile has been run to the end, the system has all the process data which you can save.

Once it is saved, you can run this profile without connecting the thermocouple (TC). The heating process will be the same as long as the same working conditions are respected.

The profiles which already have the data from the *Teach profile* are marked with this symbol 

These profiles can be run either with or without the Thermocouples. It can be chosen from the *Profiles* mode work screen:



Profile Editor



Profile Editor

The *Profile editor* can be opened from the main menu or from the *Profiles* mode work screen by pressing the 'OK' button.

In this mode, the user can choose between the 3 JBC-preset profiles, or create and save up to 22 new profiles.

Profile Name

Data for these Points

Menu Options

- Add Point
- Delete Point
- Load Profile
- Save Profile
- Exit

JBC Predefined Profiles

There are 3 profiles predefined by JBC: A, B and C. The difference between them is the number of steps: 2, 3 or 4. The thicker your PCB is and the more layers it contains, the more steps are needed to obtain gradual warming.

Predefined profiles use the low position of the support.

These profiles are not modifiable but they can be used as templates to create your own profiles.

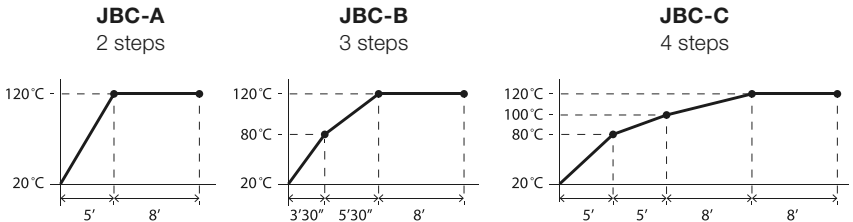

Reference-PCB specifications: FR4 1.6mm thick and 2 layers.

FR4 1.6mm thick and 6 layers.

FR4 2.2mm thick and 6 layers.

Process Analysis



Graphics

By pressing **Graphics** in the main MENU, the temperature of TC1 thermocouple and power figures in real time are displayed.

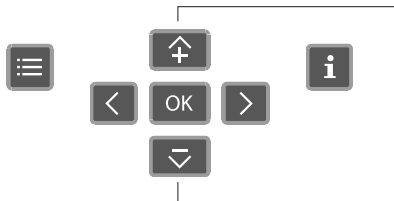
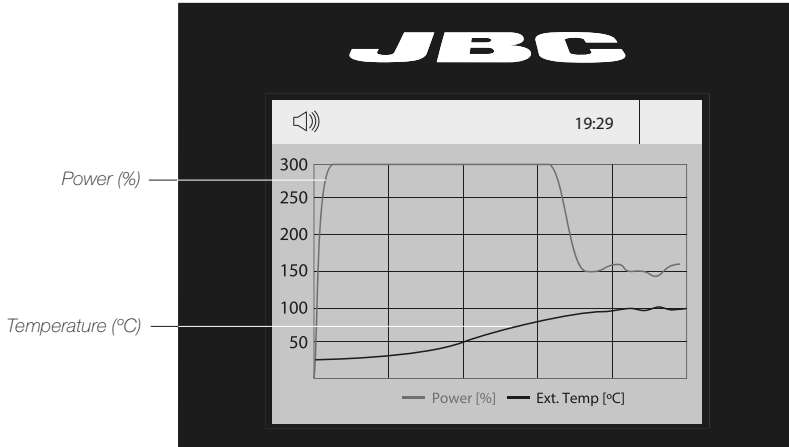

Press the up/down buttons to change between power and temperature indication on the y-axis.

Files



Files

Export Graphics

Insert a USB flash drive into the USB-A connector to save your soldering process in CSV format.

Export / Import Profiles

Insert a USB flash drive into the USB-A connector to export/import profiles.

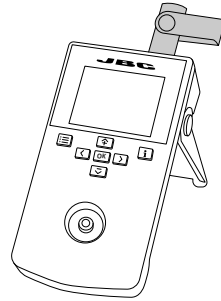

Update the Station Software

1. Download the JBC Update File from www.jbctools.com/software.html and save it on a USB flash drive. (Preferably one with no other files).



2. Insert the USB flash drive into the console. The icon  is displayed while updating.

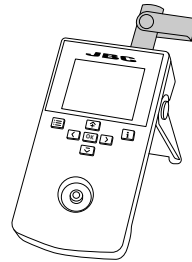

Working with Pedal

Press the pedal to start heating and press again to stop as if it were the button on the console. Once the Work Mode is set, the Heater Unit can work without the console using the pedal.

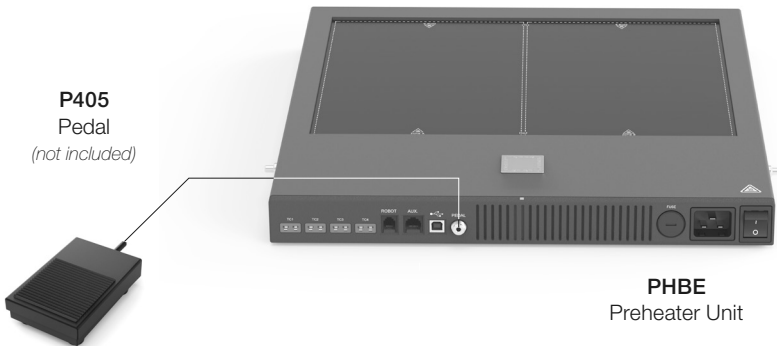

Maintenance

Before carrying out maintenance or storage, always allow the equipment to cool down.

- Check periodically that the equipment is clean.
- Use a damp cloth when cleaning. Alcohol can only be used to clean the metal parts.
- Only if it is absolutely necessary and if cleaning with isopropyl alcohol (IPA) is not enough, it is recommended to use a scraper to remove dirt in the glass area.
- Replace any defective or damaged parts. Use original JBC spare parts only.
- Repairs should only be performed by a JBC authorized technical service.
- Replace a blown fuse as follows:

Sliding
Guide
Axes

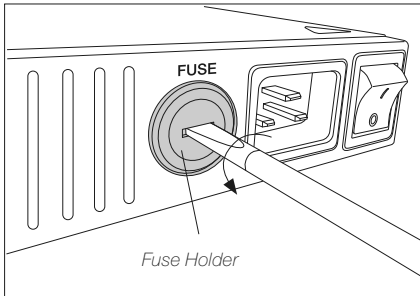
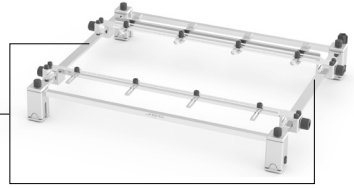

Remove the fuse holder by turning the holder counter-clockwise with a flat head screwdriver.

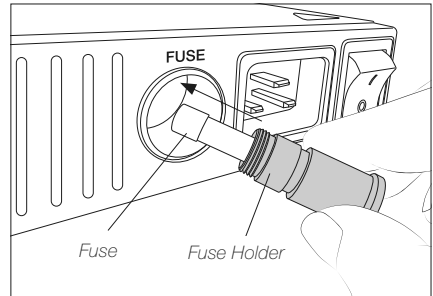

Remove the worn fuse and replace it with a new one. Reinstall the fuse holder into the preheater by screwing it in clockwise.

Safety



It is imperative to follow safety guidelines to prevent electric shock, injury, fire or explosion.

- Do not use the units for any purpose other than PCB preheating. Incorrect use may cause a fire.
- The mains cable must be plugged into approved bases. Make sure that it is properly grounded before use. When unplugging it, hold the plug, not the wire.
- The temperature of accessible surfaces may remain high after the unit is turned off. Handle with care.
- Do not leave the appliance unattended when it is on.
- Do not cover the ventilation grills. Heat can cause inflammable products to ignite.
- Heat can cause inflammable products to ignite even when out of sight.
- Be careful with the remains of liquid tin. In contact with the skin, it can cause burns.
- Avoid flux coming into contact with skin or eyes to prevent irritation.
- Be careful with the smoke produced when soldering.
- Keep your workplace clean and tidy. Wear appropriate protection glasses and gloves when working to avoid personal harm.
- This appliance can be used by children over the age of eight as well as persons with reduced physical, sensory or mental capabilities or lacking experience provided that they have been given adequate supervision or instruction concerning the use of the appliance and understand the hazards involved. Children must not play with the appliance.
- Maintenance must not be carried out by children unless supervised.

Specifications

PHBEK

Preheater Set for PCBs up to 36x28cm/14x11"

Ref. **PHBE-9KB** 100 V. Input 100 V 50/60 Hz. Fuse 20 A.

Ref. **PHBE-1KB** 120 V. Input 120 V 50/60 Hz. Fuse 20 A.

Ref. **PHBE-2KB** 230 V. Input 230 V 50/60 Hz. Fuse 10 A.

| | |
|---|--|
| - Total Net Weight: | 9.70 kg / 21.38 lb |
| - Total Package Dimensions / Weight: (L x W x H) | 705 x 625 x 365 mm / 15.65 kg 27.76 x 24.61 x 14.37 in / 34.50 lb |

PHBE Preheater Unit

| | |
|--|--|
| - Maximum Power: | |
| Ref. PHBE-9B | 1400 W |
| Ref. PHBE-1B | 1800 W |
| Ref. PHBE-2B | 1800 W |
| - Heating Area: | 180 x 277 mm / 7.10 x 10.91 in - 1 zone 360 x 277 mm / 14.17 x 10.91 in - 2 zones |
| - Ambient Operating Temperature: | 10 - 40 °C / 50 - 104 °F |
| - Temperature Range: | 50 - 250 °C / 120 - 482 °F |
| - Temperature Measurement: | Thermocouple type K Accuracy: ± 5 °C / ± 10 °F |
| - JBCset Temperature Profiles: | 3 profiles (2, 3 or 4 steps) |
| - User Profiles: | 22 (up to 16 steps for each) |
| - Maximum Work Time: | 50 min or indefinite |
| - Preheater Dimensions: (L x W x H) | 426 x 444 x 41 mm 16.77 x 17.48 x 1.61 in |

PHBS Support

| | |
|--|--|
| - Support Dimensions - Low Position: (L x W x H) | 432 x 514 x 78 mm 17.01 x 20.24 x 3.07 in |
| - Support Dimensions - High Position: (L x W x H) | 432 x 514 x 98 mm 17.01 x 20.24 x 3.86 in |
| - Max. PCB Dimensions (Between Clamps): | 36 x 28 cm / 14.17 x 11.02 in Thickness: 6 mm / 0.24 in |

Complies with CE standards.
ESD safe.

JBC

Warranty

JBC's 2 year warranty covers this equipment against all manufacturing defects, including the replacement of defective parts and labor.

Warranty does not cover product wear or misuse.

In order for the warranty to be valid, equipment must be returned, postage paid, to the dealer where it was purchased.

Get 1 extra year JBC warranty by registering here: <https://www.jbctools.com/productregistration/> within 30 days of purchase.

If you register, you will receive e-mail notifications about new software updates for your registered product.



This product should not be thrown in the garbage.

In accordance with the European directive 2012/19/EU, electronic equipment at the end of its life must be collected and returned to an authorized recycling facility.

CE EAC UK
CA

www.jbctools.com

0029844-010425